

Rev	Date	Modified by	Description
A0	2023		

## Product Specifications

### 10Gb/s SFP+ Tunable DWDM ZR 80km DDM Transceiver

PN: ESTDxxX-3LCD80

#### Features

- Support data rate up to 11.3Gb/s
- Support 80 km link distances
- 50GHz ITU-based channel spacing
- (C-Band) with a wavelength locker
- Monolithic MZM Tunable TOSA
- APD receiver with limiting amplifier
- Duplex LC connector
- Low power consumption:
- Commercial: <1.8W
- Industrial: <2.5W
- Positive power supply lines: 3.3 V
- Operating case temperature range:
- Commercial: 0 to 70 deg C
- Industrial: -40 to 85 deg C
- RoHS 6 compliant
- Compliant with SFF-8431 / SFF-8690



#### Applications

- DWDM 10Gb/s SONET/SDH
- DWDM 10Gb/s Ethernet
- DWDM 10Gb/s SONET/SDH w/FEC

## PRODUCT DESCRIPTION

The ESTDxxX-3LCD80 is a hot pluggable 3.3V Small-Form-Factor pluggable tunable SFP+ transceiver module for use in the up to 11.3Gb/s single mode high-speed communications equipment . Digital diagnostic functions are available via 2-wire serial interface, as specified in SFF-8431.

## Wavelength Guide Table

ESTDxxX-3LCD80 Wavelength table:

Channel	Wavelength (nm)	Frequency (THZ)	Channel	Wavelength (nm)	Frequency (THZ)
1	1566.72	191.35	50	1546.92	193.8
2	1566.31	191.4	51	1546.52	193.85
3	1565.9	191.45	52	1546.12	193.9
4	1565.5	191.5	53	1545.72	193.95
5	1565.09	191.55	54	1545.32	194
6	1564.68	191.6	55	1544.92	194.05
7	1564.27	191.65	56	1544.53	194.1
8	1563.86	191.7	57	1544.13	194.15
9	1563.45	191.75	58	1543.73	194.2
10	1563.05	191.8	59	1543.33	194.25
11	1562.64	191.85	60	1542.94	194.3
12	1562.23	191.9	61	1542.54	194.35
13	1561.83	191.95	62	1542.14	194.4
14	1561.42	192	63	1541.75	194.45
15	1561.01	192.05	64	1541.35	194.5
16	1560.61	192.1	65	1540.95	194.55
17	1560.2	192.15	66	1540.56	194.6
18	1559.79	192.2	67	1540.16	194.65
19	1559.39	192.25	68	1539.77	194.7
20	1558.98	192.3	69	1539.37	194.75
21	1558.58	192.35	70	1538.98	194.8
22	1558.17	192.4	71	1538.58	194.85
23	1557.77	192.45	72	1538.19	194.9
24	1557.36	192.5	73	1537.79	194.95
25	1556.96	192.55	74	1537.4	195
26	1556.55	192.6	75	1537	195.05
27	1556.15	192.65	76	1536.61	195.1
28	1555.75	192.7	77	1536.22	195.15

29	1555.34	192.75	78	1535.82	195.2
30	1554.94	192.8	79	1535.43	195.25
31	1554.54	192.85	80	1535.04	195.3
32	1554.13	192.9	81	1534.64	195.35
33	1553.73	192.95	82	1534.25	195.4
34	1553.33	193	83	1533.86	195.45
35	1552.93	193.05	84	1533.47	195.5
36	1552.52	193.1	85	1533.07	195.55
37	1552.12	193.15	86	1532.68	195.6
38	1551.72	193.2	87	1532.29	195.65
39	1551.32	193.25	88	1531.9	195.7
40	1550.92	193.3	89	1531.51	195.75
41	1550.52	193.35	90	1531.12	195.8
42	1550.12	193.4	91	1530.72	195.85
43	1549.72	193.45	92	1530.33	195.9
44	1549.32	193.5	93	1529.94	195.95
45	1548.91	193.55	94	1529.55	196
46	1548.51	193.6	95	1529.16	196.05
47	1548.11	193.65	96	1528.77	196.1
48	1547.72	193.7			
49	1547.32	193.75			

Notes:

1. ESTDxxX-3LCD80 module default channel is channel1(1566.72nm) for the first time power on.
2. The Module will remain last channel selected when power cycled.

## Absolute Maximum Ratings

Parameter	Symbol	Min	Typ	Max	Units
Storage Temperature	T <sub>stg</sub>	-40	-	85	°C
Relative Humidity - Storage	RH <sub>o</sub>	5	-	95	%
Relative Humidity - Operating	RH <sub>s</sub>	5	-	85	%
Power Supply	V <sub>cc</sub>	-0.5	-	3.6	V

## Recommended Operating Conditions

Parameter	Symbol	Min	Typ	Max	Units	Notes
Case Operating Temperature		-40	25	85	°C	Temperature Range = I
Case Operating Temperature		0	25	70	°C	Temperature Range = C
DC Supply Voltage	V <sub>CC</sub>	3.13	-	3.47	V	

## Electrical Characteristics

Parameter	Symbol	Min	Typ	Max	Units	Notes
<b>Transmitter</b>						
Differential Data input Swing	V <sub>IN</sub>		-	900	mV	Refer to CEI-28G_VSR
Input Differential Impedance	Z <sub>in</sub>	-	100	-	Ω	
Transmitter Disable Voltage	V <sub>D</sub>	2	-	V <sub>CC</sub>	V	
Transmitter Enable Voltage	V <sub>EN</sub>	0	-	0.8	V	
<b>Receiver</b>						
Differential Data Output Swing	V <sub>OUT</sub>	450	600	750	mV	
Output Differential Impedance	Z <sub>out</sub>	-	100	-	Ω	
LOS Assert Voltage	V <sub>LOSA</sub>	2	-	V <sub>CC</sub>	V	
LOS De-assert Voltage	V <sub>LOSD</sub>	0	-	0.8	V	

## Timing Characteristics

Parameter	Symbol	Min	Typ	Max	Units	Notes
Time to initialize cooled module	t <sub>start_up_cooled</sub>	-	-	90	S	

## Optical Characteristics

Parameter	Symbol	Min	Typ	Max	Units	Notes
<b>Transmitter</b>						
Average Output Power	P <sub>OUT</sub>	-1	-	4	dBm	

Center Wavelength	$\lambda_c_{BOL}$	z-1.5	z	Z+1.5	GHz	
Center Wavelength	$\lambda_c_{EOL}$	z-2.5	z	Z+2.5	GHz	
Center Wavelength Spacing		-	50	-	GHz	
Side Mode Suppression Ratio	SMSR	30	-	-	dB	
Average Output Power (Laser Off)	$P_{OFF}$	-	-	-30	dBm	
Dispersion Penalty	DP	-	-	3	dB	
Extinction ratio	ER	8.2	-	-	dB	
Relative Intensity Noise	RIN	-	-	-128	dB/Hz	
Optical Return Loss Tolerance	ORLT	-	-	20	dB	
<b>Receiver</b>						
Center Wavelength		1260		1600	nm	
Received Sensitivity (Average Power)	PIN	-	-	-24	dBm	Note3
Optical Power Overload	POL	-7	-	-	dBm	
Receiver Reflectance	RFL	-	-	-27	dB	
Rx_LOS of Signal Assert	PA	-36	-	-	dBm	
Rx_LOS of Signal De-assert	PD	-	-	-25	dBm	
Rx_LOS of Signal Hysteresis	PHy	0.5	-	6	dB	

Notes:

1. The optical power is launched into SMF
2.  $\lambda$  is wavelength of room temperature
3. Measured with RPBS 2^31-1 test pattern @10.3125Gb/s, ER=8.2dB , BER=1E-12

## Digital Diagnostic Monitor Accuracy

The following characteristics are defined over recommended operating condition

Parameter	Range	Accuracy	Unit	Calibration
Temperature	-40 to 85	±3	°C	Internal
Voltage	0 to Vcc	±3%	V	Internal
Tx Bias Current	0 to 100	±10%	mA	Internal
Tx Output Power	-6 to 0	±3	dB	Internal
Rx Input Power	-15 to 0.5	±3	dB	Internal

## Pin Diagram

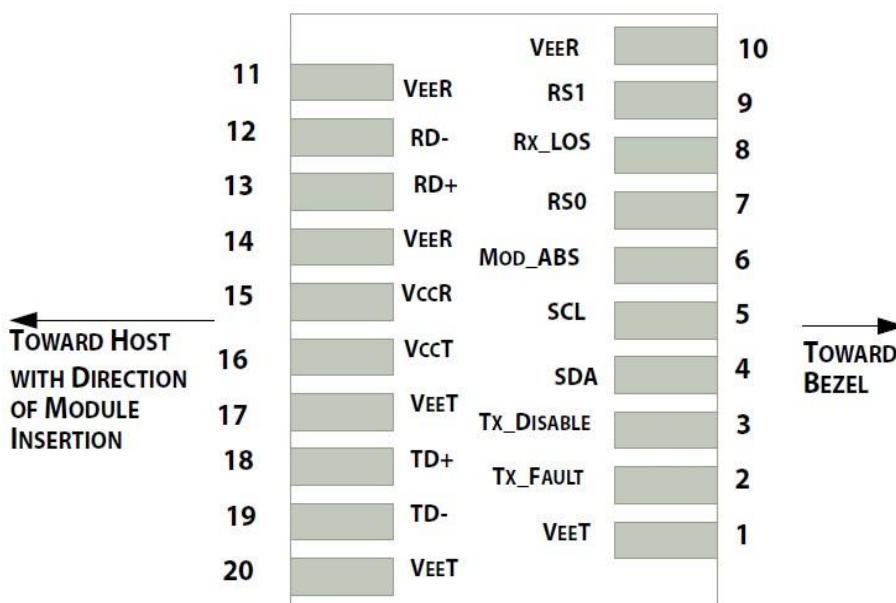

## Pin Descriptions

PIN #	Name	Function	Notes
1	VeeT	Module transmitter ground	1
2	Tx Fault	Module transmitter fault	2
3	Tx Disable	Transmitter Disable; Turns off transmitter laser output	3
4	SDL	2 wire serial interface data input/output (SDA)	4
5	SCL	2 wire serial interface clock input (SCL)	4
6	MOD-ABS	Module Absent, connect to VeeR or VeeT in the module	4
7	RS0	Rate select0, optionally control SFP+ receiver. When high, input data rate >4.5Gb/ s; when low, input data rate <=4.5Gb/s	5
8	LOS	Receiver Loss of Signal Indication	6
9	RS1	Rate select0, optionally control SFP+ transmitter. When high, input data rate >4.5Gb/s; when low, input data rate <=4.5Gb/s	1
10	VeeR	Module receiver ground	1
11	VeeR	Module receiver ground	1
12	RD-	Receiver inverted data out put	
13	RD+	Receiver non-inverted data out put	
14	VeeR	Module receiver ground	1
15	VccR	Module receiver 3.3V supply	
16	VccT	Module transmitter 3.3V supply	
17	VeeT	Module transmitter ground	1
18	TD+	Transmitter inverted data out put	
19	TD-	Transmitter non-inverted data out put	
20	VeeT	Module transmitter ground	1

**Notes:**

1. Circuit ground is internally isolated from chassis ground
2. Tx FAULT is an open collector/drain output, which should be pulled up with a 4.7k – 10k Ohms resistor on the host board if intended for use. Pull up voltage should be between 2.0V to Vcc + 0.3V. A high output indicates a transmitter fault caused by either the TX bias current or the TX output power exceeding the preset alarm thresholds. A low output indicates normal operation. In the low state, the output is pulled to <0.8V.
3. Laser output disabled on Tx DIS >2.0V or open, enabled on Tx DIS <0.8V.
4. Should be pulled up with 4.7kΩ- 10kΩ host board to a voltage between 2.0V and 3.6V. MOD\_ABS pulls line low to indicate module is plugged in.
5. Internally pulled down per SFF-8431 Rev 4.1.
6. LOS is open collector output. It should be pulled up with 4.7kΩ – 10kΩ on host board to a voltage between 2.0V and 3.6V. Logic 0 indicates normal operation; logic 1 indicates loss of signal.

**Recommend Circuit Schematic**

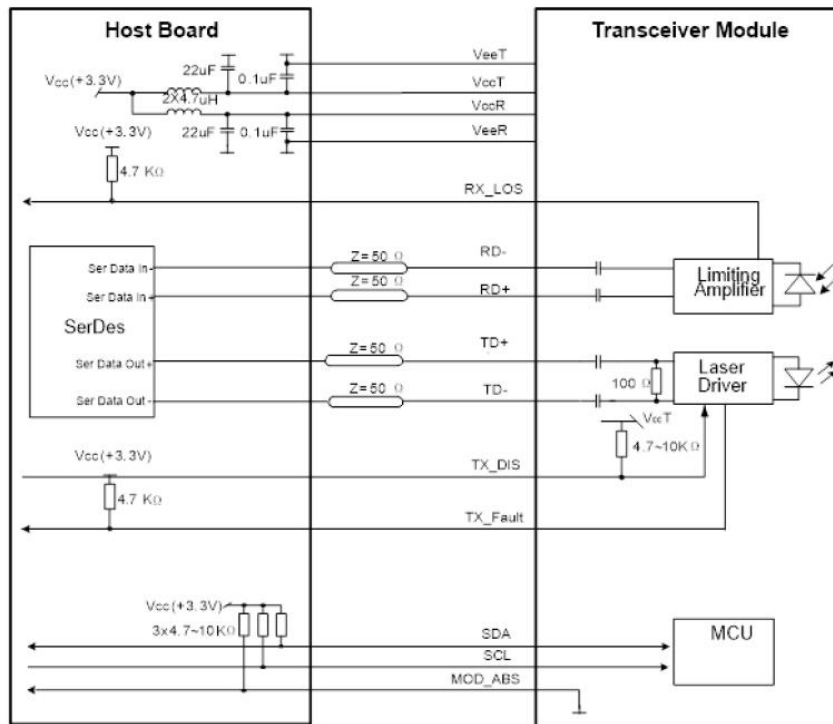

## Mechanical Specifications(Unit: mm)

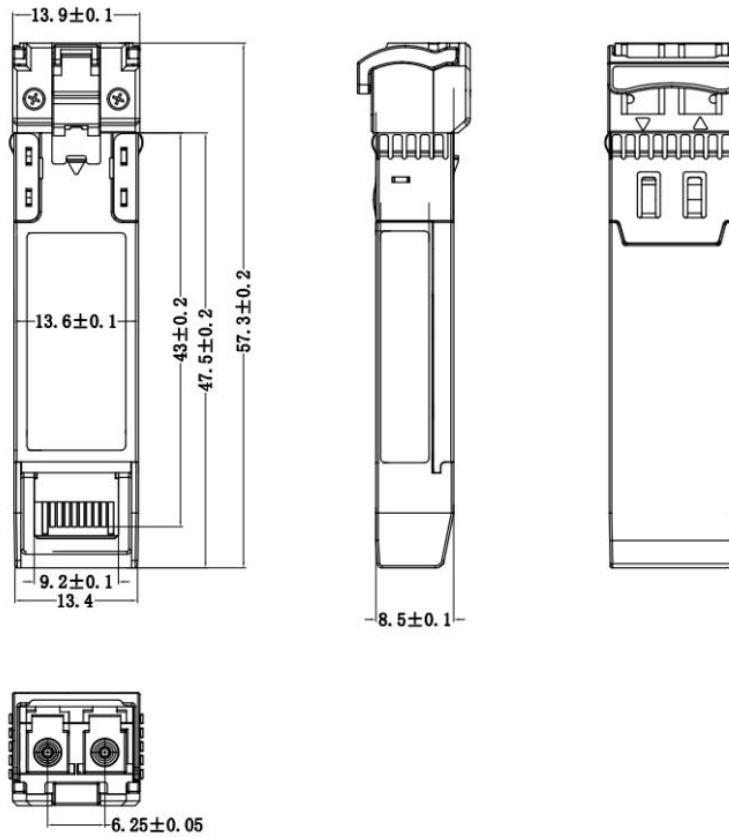

## Ordering information

Part Number	Product Description
ESTDxxX-3LCD80	10G SFP+ 80km Tunable transceiver, 50GHz Spacing, 96ch, 191.35~196.10 THz (1566.72~1528.77nm), RX APD, C-TEMP 0~70°C
ESTDxxX-3LID80	10G SFP+ 80km Tunable transceiver, 50GHz Spacing, 96ch, 191.35~196.10 THz (1566.72~1528.77nm), RX APD, I-TEMP -40~85°C



## Compatibility Test

In order to ensure the product compatibility, our products will be tested on the switch before shipment. Our modules can compatible with many mainstream brand switches, such as Cisco, Juniper, Extreme, Brocade, IBM, H3C, HP, Huawei, D-Link, Mikrotik, ZTE, TP-Link...

Our test equipment: VOLKTEK MEN-4110, HP 2530-8G, CRS226-24G-25+RM, Catalyst 2960G Series, Catalyst 3850 XS 10G SFP+, Catalyst 3750-E Series, HUAWEI S5700Series, H3C S3100V2 Series, Juniper-EX4200, etc.



HUAWEI S6720S

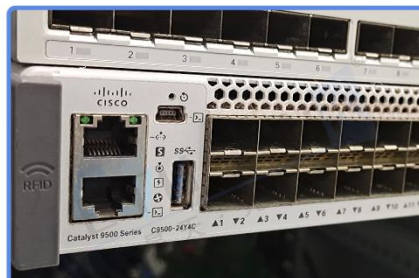

CISCO Catalyst 9500



DELL S5048F



H3C S3100V2

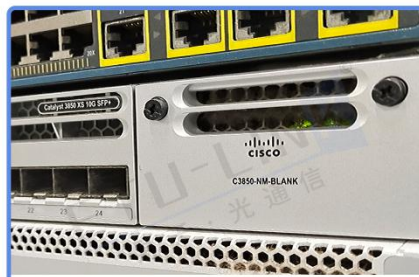

CISCO C3850



Aruba 2930F



Juniper EX 4200



HP J9264A

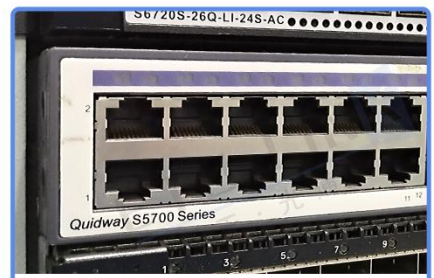

Quidway S5700

## Product Production Process

# Quality Assurance

Continuous introduction of new equipment,  
produced by strict standards, strict quality inspection,  
to guarantee the high quality, standard of each product.

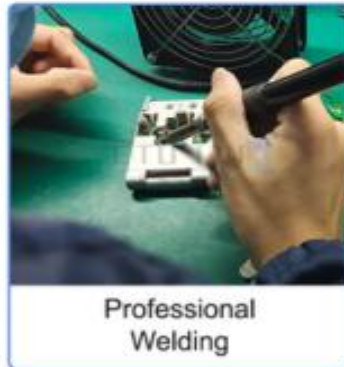

## Packaging

ETU-Link provides two kinds of packaging, 10pcs/Tray and individual package.



Company: ETU-Link Technology Co., LTD

Address: Right side of 3rd floor, No. 102 building, Longguan expressway, Dalang street,  
Longhua District, Shenzhen city, Guangdong Province, China 518109

Tel: +86-755 2328 4603

Addresses and phone number also have been listed at [www.etulinktechnology.com](http://www.etulinktechnology.com).

Please e-mail us at [sales@etulinktechnology.com](mailto:sales@etulinktechnology.com) or call us for assistance.