

### QSFP+

#### EQA4X-34S3CDxx

#### 40G QSFP+ to 4X 10G SFP+ Active Optical Cables

- Compliant to the 40GBASE-SR4 and XLPP1
- Specification per IEEE 802.3ba-2010 and supporting
- 40G-IB-QDR / 20G-IB-DDR / 10G-IB-SDR applications
- Compliant to the industry standard SFF-8436
- QSFP+ Specification
- Power Level 1: Max Power < 1.5 W
- Operate at 10.3125Gbps per channel with 64b/66b
- encoded data for 40GbE application and at 10Gbps
- with 8b/10b compatible encoded data for 40G-IB-QDR application



## Applications

- 40GbE and 10GbE break-out applications for Datacom switch and router connections
- 40G to 4×10G density applications for Datacom and Proprietary protocol applications
- Datacenter

## Description

The ETU-LINK Technologies EQA4X-34S3CDxx is a Four-Channel, Pluggable, Parallel, and Fiber-Optic QSFP+ Active Optical Cable (AOC) to 4× SFP+ Active Optical Cable break-out solution. This Breakout cable is intended for 40G to 4× 10G applications.

This AOC is a high performance cable for short-range multi-lane data communication and interconnect applications. It integrates four data lanes in each direction with 40Gbps aggregate bandwidth. Each lane can operate at 10.3125 Gbps. These cables also support 4 x 10G InfiniBand QDR applications and are backwards compatible to the 4 × 5G IB DDR and 4 × 2.5G IB single IB SDR applications.

This product is leveraged from ETU-LINK Technologies QSFP+ to QSFP+ Active Optical Cable product and SFP+ Active Optical Cable product. Where applicable, consult these respective datasheets

This AOC incorporates ETU-LINK Technologies' proven integrated circuit and VCSEL technology to provide reliable long life, high performance, and consistent service.

## Active Optical Cable Assembly

- 0 to 70 C degree case temperature operating range
- Proven High Reliability 850 nm technology: VCSEL transmitter and PIN receiver
- Hot pluggable for ease of servicing and installation
- Two Wire Serial interface
- Utilizes optical fiber for high density and thin, lightweight cable management

## Each 4× SFP+ end

- Compliant to the electrical specifications per SFF-8431 Specifications for Enhanced Small Form Factor Pluggable Module
- Mechanical specifications per SFF Committee SFF-8432 Improved Pluggable Form factor "IPF"
- Maximum power dissipation 0.35W per end.

## Absolute Maximum Ratings

The operation in excess of any absolute maximum ratings might cause permanent damage to this module.

Parameter	Symbol	Min	Max	Unit	Note
Storage Temperature	TST	-40	85	degC	
Relative Humidity(non-condensing)	RH	0	85	%	
Operating Case Temperature	TOPC	0	70	degC	
Supply Voltage	VCC	-0.3	3.6	V	
Input Voltage	Vin	-0.3	Vcc+0.3	V	

Parameter	Symbol	Min	Typical	Max	Unit
Operating Case Temperature	TOPC	0		70	degC
Power Supply Voltage	VCC	3.13	3.3	3.47	V
Data Rate	DR		10.3	11.3	Gbps
Data Speed Tolerance	ΔDR	-100		+100	ppm
Link Distance with OM3 fiber	D	0		100	m
Control* Input Voltage High	Vih	2		VCC+0.3	V
Control* Input Voltage Low	Vil	-0.3		0.8	V
I2C Serial Interface frequency	fs			400k	Hz
Power Supply Noise				50	mVpp
Receiver Differential Data Output Load				100	mVpp

## Active Cable-End Electrical Characteristics

The following characteristics are defined over the Recommended Operating Conditions unless otherwise noted. Typical values are for  $T_c = 40\text{ }^\circ\text{C}$ ,  $V_{cc} = 3.3\text{ V}$

Parameter	Symbol	Min	Typical	Max	Unit
QSFP+40G Active Cable-End Power Consumption				1.5	W
QSFP+ 40G Active Cable-End Power Supply Current				300	mA
SFP+ 10G Active Cable-End Power Consumption				0.35	W
SFP+ 10G Active Cable-End Power Supply Current				100	mA

Parameter	Symbol	Min	Typical	Max	Unit
Differential input impedance	$Z_{in}$	90	100	110	ohm
Differential Output impedance	$Z_{out}$	90	100	110	ohm
Differential input voltage amplitude	$\Delta V_{in}$	300		1100	mVp-p
Differential output voltage amplitude	$\Delta V_{out}$	400		800	mVp-p
Bit Error Rate	BR			E-12	
Input Logic Level High	$V_{IH}$	2.0		$V_{CC}$	V
Input Logic Level Low	$V_{IL}$	0		0.8	V
Output Logic Level High	$V_{OH}$	$V_{CC}-0.5$		$V_{CC}$	V
Output Logic Level Low	$V_{OL}$	0		0.4	V

## QSFP+ AOC - end Pin Descriptions

PIN	Logic	Symbol	Name/Description	Note
1		GND	Ground	1
2	CML-I	Tx2n	Transmitter Inverted Data Input	
3	CML-I	Tx2p	Transmitter Non-Inverted Data output	
4		GND	Ground	1
5	CML-I	Tx4n	Transmitter Inverted Data Input	
6	CML-I	Tx4p	Transmitter Non-Inverted Data output	
7		GND	Ground	1
8	LVTLL-I	ModSelL	Module Select	
9	LVTLL-I	ResetL	Module Reset	
10		VccRx	+ 3.3V Power Supply Receiver	2
11	LVC MOS-I/O	SCL	2-Wire Serial Interface Clock	
12	LVC MOS-I/O	SDA	2-Wire Serial Interface Data	
13		GND	Ground	
14	CML-O	Rx3p	Receiver Non-Inverted Data Output	
15	CML-O	Rx3n	Receiver Inverted Data Output	
16		GND	Ground	1
17	CML-O	Rx1p	Receiver Non-Inverted Data Output	
18	CML-O	Rx1n	Receiver Inverted Data Output	
19		GND	Ground	1
20		GND	Ground	1
21	CML-O	Rx2n	Receiver Inverted Data Output	
22	CML-O	Rx2p	Receiver Non-Inverted Data Output	
23		GND	Ground	1
24	CML-O	Rx4n	Receiver Inverted Data Output	1
25	CML-O	Rx4p	Receiver Non-Inverted Data Output	
26		GND	Ground	1
27	LVTTL-O	ModPrsL	Module Present	
28	LVTTL-O	IntL	Interrupt	
29		VccTx	+3.3 V Power Supply transmitter	2
30		Vcc1	+3.3 V Power Supply	2
31	LVTTL-I	LPMode	Low Power Mode	
32		GND	Ground	1
33	CML-I	Tx3p	Transmitter Non-Inverted Data Input	
34	CML-I	Tx3n	Transmitter Inverted Data Output	
35		GND	Ground	1

36	CML-I	Tx1p	Transmitter Non-Inverted Data Input	
37	CML-I	Tx1n	Transmitter Inverted Data Output	
38		GND	Ground	1

#### Notes:

- 1) Module circuit ground is isolated from module chassis ground within the module. GND is the symbol for signal and supply (power) common for QSFP modules.
- 2) The connector pins are each rated for a maximum current of 500mA.

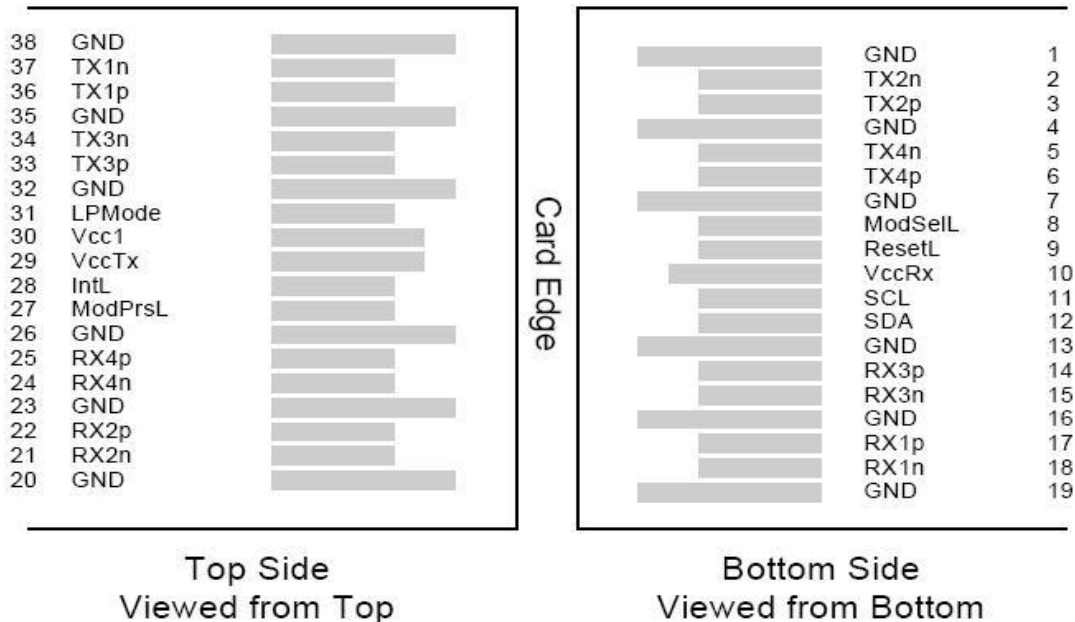

### ModSelL Pin

The ModSelL is an input pin. When held low by the host, the module responds to 2-wire serial communication commands. The ModSelL allows the use of multiple QSFP modules on a single 2-wire interface bus. When the ModSelL is “High”, the module will not respond to any 2-wire interface communication from the host. ModSelL has an internal pull-up in the module.

### ResetL Pin

Reset. LPMoDe\_Reset has an internal pull-up in the module. A low level on the ResetL pin for longer than the minimum pulse length ( $t_{Reset\_init}$ ) initiates a complete module reset, returning all user module settings to their default state. Module Reset Assert Time ( $t_{init}$ ) starts on the rising edge after the low level on the ResetL pin is released. During the execution of a reset ( $t_{init}$ ) the host shall disregard all status bits until the module indicates a completion of the reset interrupt. The module indicates this by posting an IntL signal with the Data\_Not\_Ready bit negated. Note that on power up (including hot insertion) the module will post this completion of reset interrupt without requiring a reset.

### LPMoDe Pin

ETU-Link QSFP+ SR4operate in the low power mode (less than 1.5 W power consumption). This pin active high will decrease power consumption to less than 1W.

### ModPrsL Pin

ModPrsL is pulled up to Vcc on the host board and grounded in the module. The ModPrsL is asserted “Low” when the module is inserted and de-asserted “High” when the module is physically absent from the host connector.

## IntL Pin

IntL is an output pin. When “Low”, it indicates a possible module operational fault or a critical status to the host system. The host identifies the source of the interrupt by using the 2-wire serial interface. The IntL pin is an open collector output and must be pulled up to Vcc on the host board.

## QSFP+ AOC-end Power Supply Filtering

The host board should use the power supply filtering shown in Figure1.

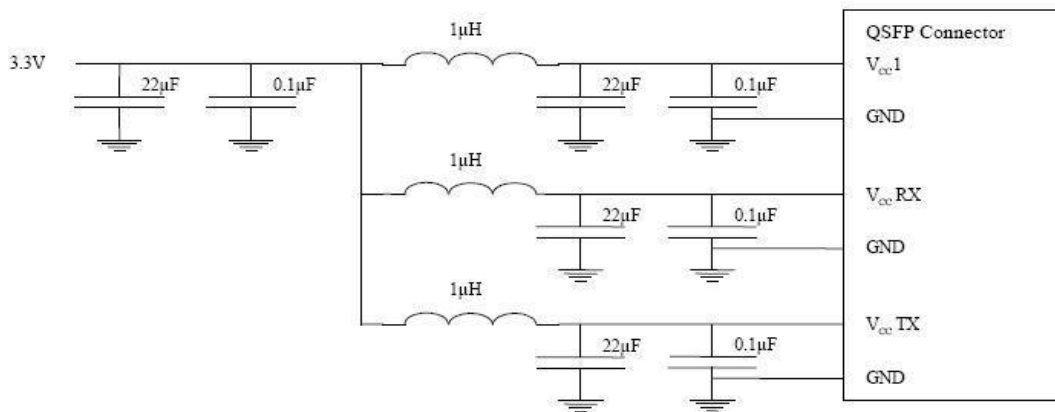

Figure1. Host Board Power Supply Filtering

## QSFP+ AOC-end EEPROM Serial ID Memory Contents

Compliant to the industry standard SFF-8436 QSFP+ Specification

## SFP+ AOC-end Electrical Specifications

Parameter	Symbol	Min	Typical	Max	Unit
Differential input impedance	Zin	90	100	110	ohm
Differential Output impedance	Zout	90	100	110	ohm
Differential input voltage amplitude a Amplitude	$\Delta V_{in}$	100		1800	mVp-p
Differential output voltage amplitude	$\Delta V_{out}$	400		800	mVp-p
Bit Error Rate	BR				E-12
Input Logic Level High	V <sub>IH</sub>	2.0		VCC	V
Input Logic Level Low	V <sub>IL</sub>	0		0.8	V

## SFP+ AOC-end Pin Descriptions

PIN	Symbol	Name/Description	Note
1	VeeT	Transmitter Signal Ground	Note 1
2	TX_FAULT	Transmitter Fault (LVTTTL-O) – Not used. Grounded inside the module	Note 2
3	TX_DISABLE	Transmitter Disable (LVTTTL-I) – High or open disables the transmitter	Note 3
4	SDA	Two Wire Serial Interface Data Line (LVCMOS – I/O) (same as MOD-DEF2 in INF-8074)	Note 4
5	SCL	Two Wire Serial Interface Clock Line (LVCMOS – I/O) (same as MOD-DEF1 in INF-8074)	Note 4
6	MOD_ABS	Module Absent (Output), connected to VeeT or VeeR in the module	Note 5
7	RS0	Rate Select 0 - Not used, Presents high input impedance.	
8	RX_LOS	Receiver Loss of Signal (LVTTTL-O)	Note 2
9	RS1	Rate Select 1 - Not used, Presents high input impedance.	
10	VeeR	Receiver Signal Ground	Note 1
11	VeeR	Receiver Signal Ground	Note 1
12	RD-	Receiver Data Out Inverted (CML-O)	
13	RD+	Receiver Data Out (CML-O)	
14	VeeR	Receiver Signal Ground	
15	VccR	Receiver Power + 3.3 V	
16	VccT	Transmitter Power + 3.3 V	
17	VeeT	Transmitter Signal Ground	Note 1
18	TD+	Transmitter Data In (CML-I)	
19	TD-	Transmitter Data In Inverted (CML-I)	
20	VeeT	Transmitter Signal Ground	Note 1

### Notes:

- 1) Module circuit ground is isolated from module chassis ground within the module. GND is the symbol for signal and supply (power) common for SFP modules.
- 2) This is an open collector/drain output that on the host board requires a 4.7 k $\Omega$  to 10 k $\Omega$  pullup resistor to VccHost. See Figure 2.
- 3) This input is internally biased high with a 4.7 k $\Omega$  to 10 k $\Omega$  pullup resistor to VccT.
- 4) Two-Wire Serial interface clock and data lines require an external pullup resistor dependent on the capacitance load.
- 5) This is a ground return that on the host board requires a 4.7 k $\Omega$  to 10 k $\Omega$  pullup resistor to VccHost.

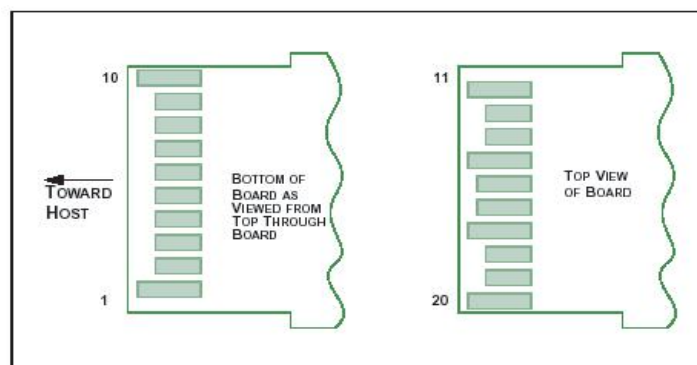
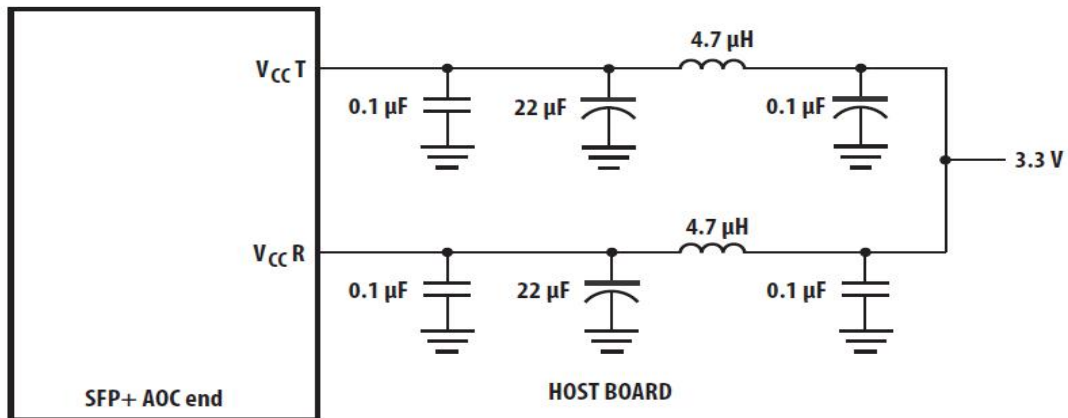

Figure 2

## SFP+ AOC-end Power Supply Filtering



NOTE: INDUCTORS MUST HAVE LESS THAN 1Ω SERIES RESISTANCE TO LIMIT VOLTAGE DROP TO THE SFP MODULE.

## Optical Fiber Specifications

Parameter	Specification
Tight buffer color	Orange
Tight buffer material	PVC
Fiber type	62.5/125 (OFS) Bandwith: 160 MHz.km @ 850 nm
Jacket material	PVC
Cable diameter mm	3.0 ± 0.1
Cable weight Kg/km	7.0
Min. bending radius mm	30
Attenuation dB/km	≤ 3.5 at 850 nm ≤ 1.5 at 1300 nm
Short tension N	120
Operation temperature °C	-20~70



## SFP+ AOC end Mechanical Specifications

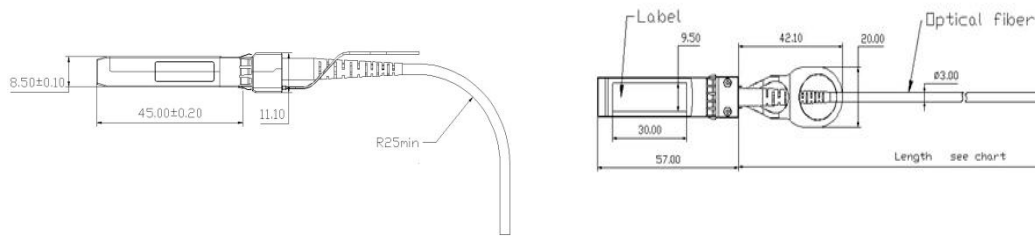

## QSFP+ AOC end Mechanical Specifications

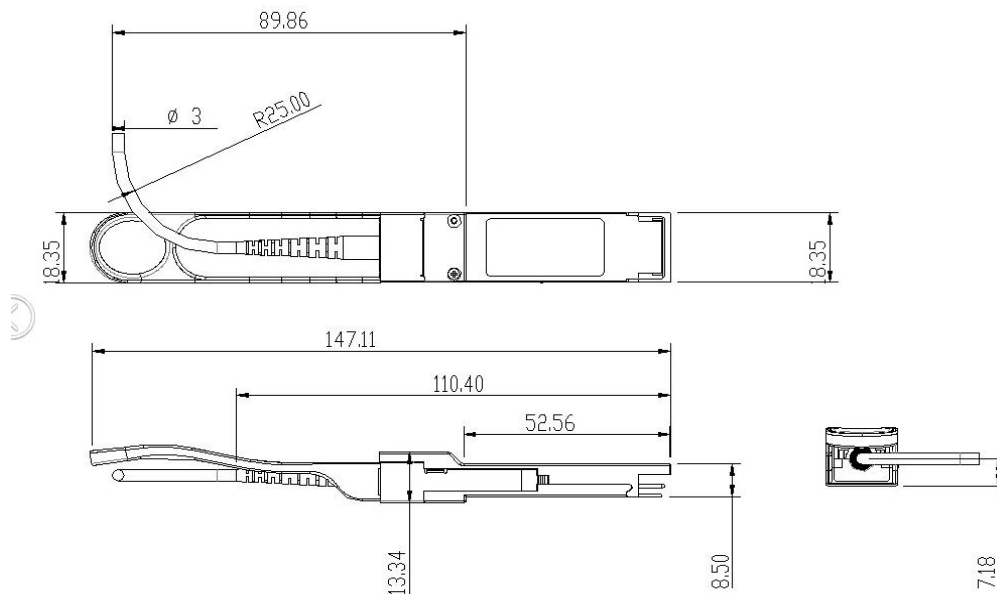

## Regulatory Compliance

Feature	Reference	Performance
Electrostatic discharge (ESD)	IEC/EN 61000-4-2	Compatible with standards
Electromagnetic Interference (EMI)	FCC Part 15 Class B EN 55022 Class B (CISPR 22A)	Compatible with standards
Laser Eye Safety	FDA 21CFR 1040.10, 1040.11 IEC/EN 60825-1, 2	Class 1 laser product
Component Recognition	IEC/EN 60950, UL	Compatible with standards
ROHS	2002/95/EC	Compatible with standards
EMC	EN61000-3	Compatible with standards

## Compatibility Test

In order to ensure the product compatibility, our products will be tested on the switch before shipment. Our modules can be compatible with many mainstream brand switches, such as Cisco, Juniper, Extreme, Brocade, IBM, H3C, HP, Huawei, D-Link, Mikrotik, ZTE, TP-Link...

Our test equipment: VOLKTEK MEN-4110, HP 2530-8G, CRS226-24G-25+RM, Catalyst 2960G Series, Catalyst 3850 XS 10G SFP+, Catalyst 3750-E Series, HUAWEI S5700Series, H3C S3100V2 Series, Juniper-EX4200, etc.



**Cisco Catalyst 3850**



**HUAWEI S5700**



**H3C S3100V2**



**HP J9264AR**



**Juniper EX 4200**



**Alcatel 6850E-U24X**



**Mikrotik CR5226-24G-25+RM**



**Cisco Catalyst 2960G**



**Volktek MEN-4110**

## Quality Assurance

Continuous introduction of new equipment, produced by strict standards, strict quality inspection, to guarantee the high quality standard of each product.



**Standardized  
Production Line**



**Professional  
Welding**



**Assembling**



**Aging Testing**

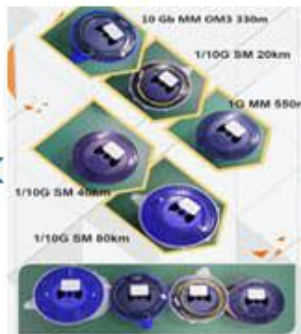

**Distance Testing**



**Cleaning end face**



**Product Initial Test**



**Switch Testing**



**Product Final Test**

## Packaging

Individual package.



Company: ETU-Link Technology Co., LTD

Address: 4th Floor, C Building, JinBoLong Industrial Park, QingQuan Road, LongHua District,  
Shenzhen city, GuangDong

Tel: +86-755 2328 4603

Addresses and phone number also have been listed at [www.etulinktechnology.com](http://www.etulinktechnology.com).

Please e-mail us at [sales@etulinktechnology.com](mailto:sales@etulinktechnology.com) or call us for assistance.