



QSFP-DD

EQD3140X-3MCD2

400G-DR4 2km QSFP-DD Transceiver

- Compliant with IEEE802.3bs standard:
 - - 400GAUI-8 electrical interface
- Compliant with IEEE 802.3cu standards:
 - - 4x 100GBASE-FR1 optical interface
- Compliant with QSFP-DD MSA HW Rev 5.1
Type 2 housing with MPO-12 connector
- Compliant with QSFP-DD CMIS Rev 4.0
- Maximum power consumption 10W
- Case operating temperature 0°C to 70°C
- Two wire serial Interface with digital diagnostic monitoring
- Complies with EU Directive 2011/65/EU
(RoHS compliant)
- Class 1 Laser



Module Characteristics

Table 1 – Absolute Maximum Ratings

Parameter	Symbol	Min.	Max.	Unit	Notes
Storage Temperature	TS	-40	85	°C	
Supply Voltage	VCC	-0.5	3.6	V	
Relative Humidity (non-condensing)	RH	5	95	%	
Control Input Voltage	VI	-0.3	VCC+0.5	V	

Table 2 – Recommended Operating Conditions

Parameter	Symbol	Min.	Typical	Max.	Unit	Notes
Operating Case Temperature	TOPR	0	-	70	°C	
Power Supply Voltage	VCC	3.135	3.3	3.465	V	
Instantaneous peak current at hot plug	ICC_IP	-	-	4000	mA	

Parameter	Symbol	Min.	Typical	Max.	Unit	Notes
Sustained peak current at hot plug	ICC_SP	-	-	3300	mA	
Maximum Power Dissipation	PD	-	-	10	W	
Maximum Power Dissipation, Low Power Mode	PDLP	-	-	1.5	W	
Signalling Rate per Lane	SRL	-	53.125	-	GBd	PAM4
Two Wire Serial Interface Clock Rate	-	-	-	400	kHz	
Power Supply Noise Tolerance (10Hz - 10MHz)	-	-	-	66	mV	
Rx Differential Data Output Load	-	-	100	-	Ohm	
Operating Distance	-	2	-	2000	m	

Functional Characteristics (Optical)

The following tables list the performance specifications for the various functional blocks of the integrated optical transceiver module.

Table 3 – Transmitter Optical Specifications

Parameter	Symbol	Min.	Typical	Max.	Unit	Notes
Wavelength	λ_C	1304.5	1311	1317.5	nm	
Side Mode Suppression Ratio	SMSR	30	-	-	dB	
Average Launch Power, each lane	AOPL	-3.1	-	4	dBm	1
Outer Optical Modulation Amplitude (OMA _{outer}), each lane	TOMA	-	-	4.2	dBm	
Outer Optical Modulation Amplitude (OMA _{outer}) each lane: for TDECQ <1.4dB for 1.4 ≤ TDECQ ≤ 3.4dB	TOMA	-0.1 -1.5 + TDECQ	-	-	dBm	
Transmitter and Dispersion Eye Closure for PAM4 (TDECQ), each lane	TDECQ	-	-	3.4	dB	
Transmitter eye closure for PAM4(TECQ)	TECQ	-	-	3.4	dB	
TDECQ - TECQ	-	-	-	2.5	dB	
Over/under-shoot	-	-	-	22	%	
Transmitter power excursion	-	-	-	2	dBm	
Average Launch Power of OFF Transmitter, each lane	TOFF	-	-	-15	dBm	

Parameter	Symbol	Min.	Typical	Max.	Unit	Notes
Extinction Ratio, each lane	ER	3.5	-	-	dB	
RIN17.1OMA	RIN	-	-	-136	dB/Hz	
Optical Return Loss Tolerance	ORL	-	-	17.1	dB	
Transmitter Reflectance	TR	-	-	-26	dB	
Transmitter Transition Time	Tt	-	-	17	ps	

Note 1: Average launch power, each lane (min) is informative and not the principal indicator of signal strength.

Table 4 – Receiver Optical Specifications

Parameter	Symbol	Min.	Typical	Max.	Unit	Notes
Wavelength	λ_C	1304.5	1311	1317.5	nm	
Damage Threshold, each lane	AOPD	5	-	-	dBm	
Average Receive Power, each lane	AOPR	-7.1	-	4	dBm	1
Receive Power (OMAouter), each lane	OMAR	-	-	4.2	dBm	
Receiver Reflectance	RR	-	-	-26	dB	
Receiver Sensitivity (OMAouter), each lane for $TECQ < 1.4\text{dB}$ for $1.4 \leq TECQ \leq 3.4\text{dB}$	SOMA	-	-	-4.5 -5.9+TECQ	dBm	
Stressed Receiver Sensitivity (OMAouter), each lane	SRS	-	-	-2.5	dBm	2
Conditions of stressed receiver sensitivity test	-	-	-	-	-	
Stressed eye closure for PAM4 (SECQ)	-	-	3.4	-	dB	

Note 1: Average receive power, (min) is informative and not the principal indicator of signal strength;

Note 2: Measured with conformance test signal at TP3 for the BER = 2.4×10^{-4} .

Functional Characteristics (Electrical)

Table 5 – Electrical Specification High Speed Signal (compliant with IEEE 802.3bs 400GAUI-8)

Receiver (Module Output)						
Parameter	Symbol	Min.	Typical	Max.	Unit	Notes
AC common-mode output Voltage (RMS)		-	-	17.5	mV	
Differential output Voltage		-	-	900	mV	
Near-end Eye height, differential		70	-	-	mV	
Far-end Eye height, differential		30	-	-	mV	

Receiver (Module Output)						
Parameter	Symbol	Min.	Typical	Max.	Unit	Notes
Far end pre-cursor ratio		-4.5	-	2.5	%	
Differential Termination Mismatch		-	-	10	%	
Transition Time (min, 20% to 80%)		9.5	-	-	ps	
DC common mode Voltage		-350	-	2850	mV	
Transmitter (Module Input)						
Parameter	Symbol	Min.	Typical	Max.	Unit	Notes
Differential pk-pk input Voltage tolerance		900	-	-	mV	
Differential termination mismatch		-	-	10	%	
Single-ended voltage tolerance range		-0.4	-	3.3	V	
DC common mode Voltage		-350	-	2850	mV	

Table 6 – Electrical Specification Low Speed Signal (compliant with QSFP-DD HW Rev 5.1)

Parameter	Symbol	Min.	Max.	Unit	Condition
Module output SCL and SDA	VOL	0	0.4	V	
Module Input SCL and SDA	VIL	-0.3	VCC*0.3	V	
	VIH	VCC*0.7	VCC+0.5	V	
InitMode, ResetL and ModSelL	VIL	-0.3	0.8	V	
	VIH	2	VCC+0.3	V	
IntL	VOL	0	0.4	V	
	VOH	VCC-0.5	VCC+0.3	V	

Pin Definitions

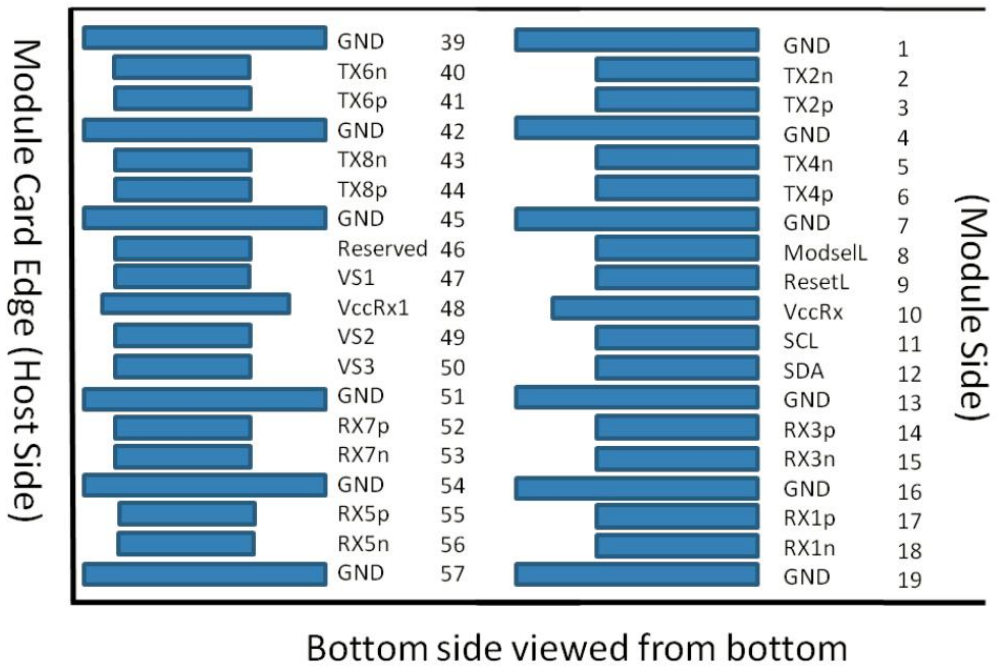
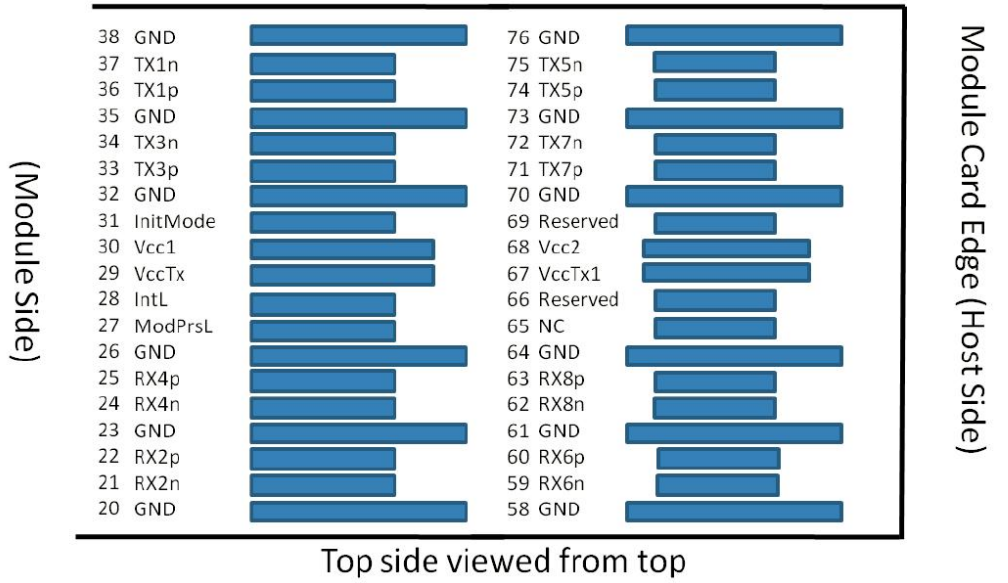

Figure 1 – Pin definitions of the module high speed inputs/outputs

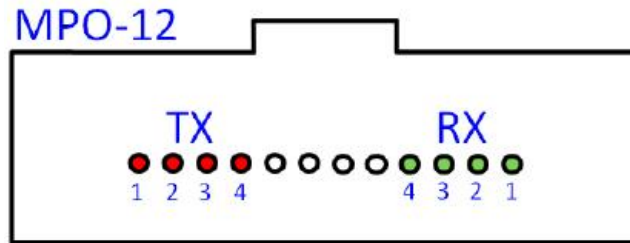

Figure 2 – Active fiber ports in MPO12 connector on module side

Table 7 – Module Pin Definitions

Pin #	Logic	Symbol	Definition	Pin #	Logic	Symbol	Definition
1		GND	Ground	39		GND	Ground
2	CML-I	Tx2n	Transmitter Inverted Data Input	40	CML-I	Tx6n	Transmitter Inverted Data Input
3	CML-I	Tx2p	Transmitter Non-inverted Data Input	41	CML-I	Tx6p	Transmitter Non-inverted Data Input
4		GND	Ground	42		GND	Ground
5	CML-I	Tx4n	Transmitter Inverted Data Input	43	CML-I	Tx8n	Transmitter Inverted Data Input
6	CML-I	Tx4p	Transmitter Non-inverted Data Input	44	CML-I	Tx8p	Transmitter Non-inverted Data Input
7		GND	Ground	45		GND	Ground
8	LVTTL-I	ModSelL	Module Select	46		Reserved	
9	LVTTL-I	ResetL	Module Reset	47		VS1	Module Vendor Specific 1
10		VccRx	+3.3V Power Supply Receiver	48		VccRx1	3.3V Power Supply
11	LVCMS-I/O	SCL	2-wire serial interface clock	49		VS2	Module Vendor Specific 2
12	LVCMS-I/O	SDA	2-wire serial interface data	50		VS3	Module Vendor Specific 3
13		GND	Ground	51		GND	Ground
14	CML-O	Rx3p	Receiver Non-inverted Data Output	52	CML-O	Rx7p	Receiver Non-inverted Data Output
15	CML-O	Rx3n	Receiver Inverted Data Output	53	CML-O	Rx7n	Receiver Inverted Data Output
16		GND	Ground	54		GND	Ground
17	CML-O	Rx1p	Receiver Non-inverted Data Output	55	CML-O	Rx5p	Receiver Non-inverted Data Output

Pin #	Logic	Symbol	Definition	Pin #	Logic	Symbol	Definition
18	CML-O	Rx1n	Receiver Inverted Data Output	56	CML-O	Rx5n	Receiver Inverted Data Output
19		GND	Ground	57		GND	Ground
20		GND	Ground	58		GND	Ground
21	CML-O	Rx2n	Receiver Inverted Data Output	59	CML-O	Rx6n	Receiver Inverted Data Output
22	CML-O	Rx2p	Receiver Non-inverted Data Output	60	CML-O	Rx6p	Receiver Non-inverted Data Output
23		GND	Ground	61		GND	Ground
24	CML-O	Rx4n	Receiver Inverted Data Output	62	CML-O	Rx8n	Receiver Inverted Data Output
25	CML-O	Rx4p	Receiver Non-inverted Data Output	63	CML-O	Rx8p	Receiver Non-inverted Data Output
26		GND	Ground	64		GND	Ground
27	LVTTTL-O	ModPrsL	Module Present	65		NC	Not connected
28	LVTTTL-O	IntL	Interrupt	66		Reserved	
29		VccTx	+3.3V Power Supply Transmitter	67		VccTx1	3.3V Power Supply
30		Vcc1	+3.3V Power Supply	68		Vcc2	3.3V Power Supply
31	LVTTTL-I	InitMode	Initialization mode	69		Reserved	
32		GND	Ground	70		GND	Ground
33	CML-I	Tx3p	Transmitter Non-inverted Data Input	71	CML-I	Tx7p	Transmitter Non-inverted Data Input
34	CML-I	Tx3n	Transmitter Inverted Data Input	72	CML-I	Tx7n	Transmitter Inverted Data Input
35		GND	Ground	73		GND	Ground
36	CML-I	Tx1p	Transmitter Non-inverted Data Input	74	CML-I	Tx5p	Transmitter Non-inverted Data Input
37	CML-I	Tx1n	Transmitter Inverted Data Input	75	CML-I	Tx5n	Transmitter Inverted Data Input
38		GND	Ground	76		GND	Ground

Recommended QSFP-DD Host Board Schematic

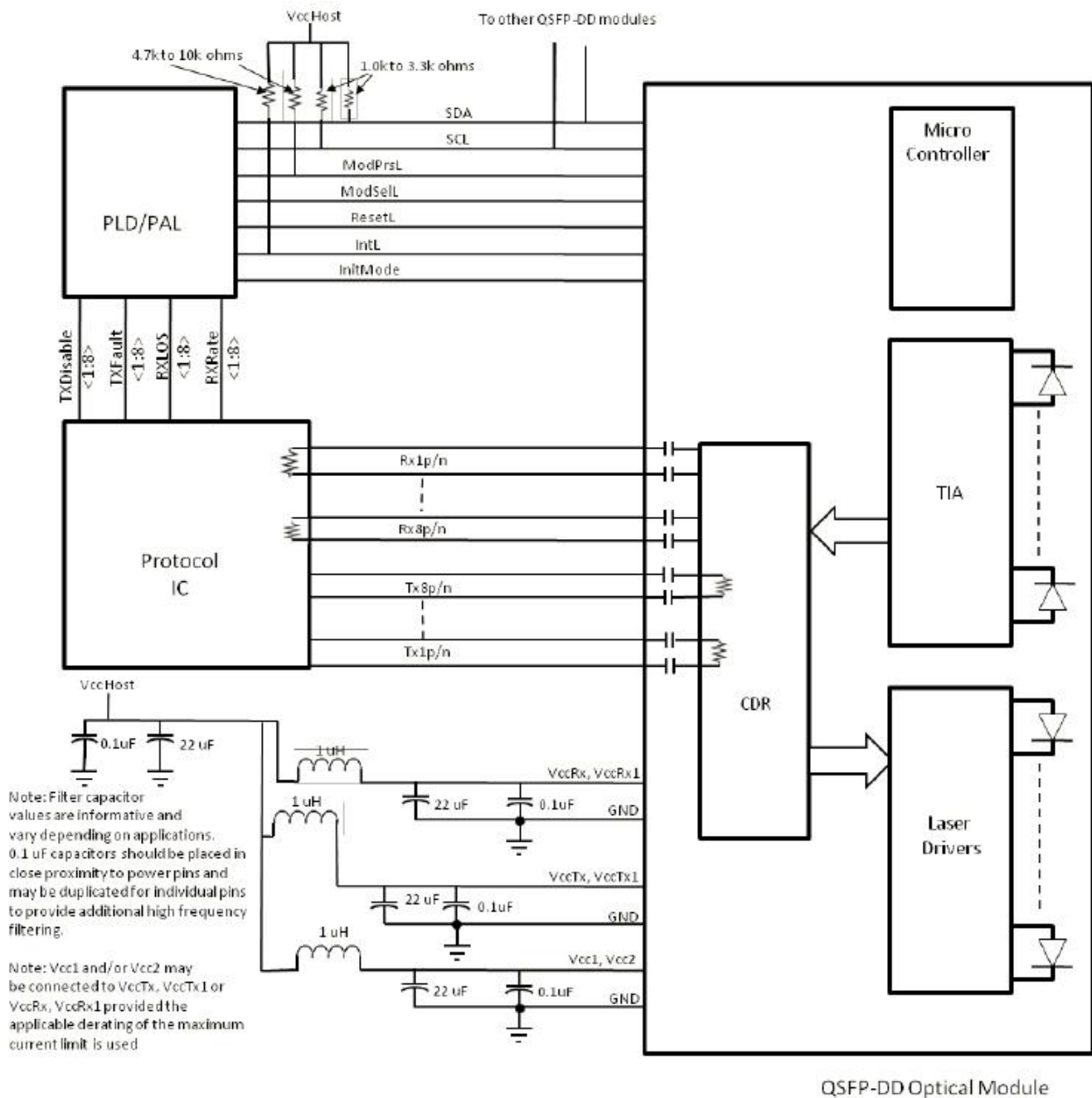

Figure 3 – Recommended QSFP-DD Host Board Schematic

Timing

Table 8 – Timing for Soft Control and Status Functions

Parameter	Symbol	Min.	Max.	Unit	Notes
MgmtInit Duration		-	2000	ms	
ResetL Assert Time	t_reset_init	10	-	μs	
IntL Assert Time	ton_IntL	-	200	ms	
IntL Deassert Time	toff_IntL	-	500	μs	
Rx LOS Assert Time (optional fast mode)	ton_losf	-	1	ms	
Tx Fault Assert Time	ton_Txfault	-	200	ms	
Flag Assert Time	ton_flag	-	200	ms	
Mask Assert Time	ton_mask	-	100	ms	
Mask Deassert Time	toff_mask	-	100	ms	

Table 9 – I/O Timing for Squelch and Disable

Parameter	Symbol	Min.	Max.	Unit	Notes
Rx Squelch Assert Time	ton_Rxsq	-	150	ms	
Tx Squelch Assert Time	ton_Txsq	-	400	ms	
Tx Squelch Deassert Time	toff_Txsq	-	1.5	s	
Tx Disable Assert Time (optional fast mode)	ton_Txdisf	-	3	ms	
Tx Disable Deassert Time (optional fast mode)	toff_Txdisf	-	10	ms	
Rx Output Disable Assert Time	ton_Rxdis	-	100	ms	
Rx Output Disable Deassert Time	toff_Rxdis	-	100	ms	
Squelch Disable Assert Time	ton_sqdis	-	N/A		Note, not support
Squelch Disable Deassert Time	toff_sqdis	-	N/A		Note, not support

Digital Diagnostics Monitor

Table 10 – Digital Diagnostics

Parameter	Range	Accuracy	Unit	Calibration
Temperature	0 to 70	±3	°C	Internal
Voltage	0 to VCC	3%	V	Internal
Tx Bias Current (Each Lane)	0 to 100	10%	mA	Internal

Parameter	Range	Accuracy	Unit	Calibration
Tx Output Power (Each Lane)	-3.1 to +4	± 3	dB	Internal
Rx Receive Power (Each Lane)	-7.1 to +4	± 3	dB	Internal

Operation Modes switchover

The module can work at 4x100G or 1x400G operation mode, it works at 4x100G mode default after power-up, please refer the following guideline for operation modes switch.

If customer want to switch to 1x400G:

- Step 1. Write A0 page 10h 80h to 0xFF;
- Step 2. Write A0 page 10h B3h to 0xFF;
- Step 3. Write A0 page 10h 80h to 0x00.

If customer want to switch to 4x100G:

- Step 1. Write A0 page 10h 80h to 0xFF;
- Step 2. Write A0 page 10h 90h to 0xFF;
- Step 3. Write A0 page 10h 80h to 0x00.

Mechanical Diagram

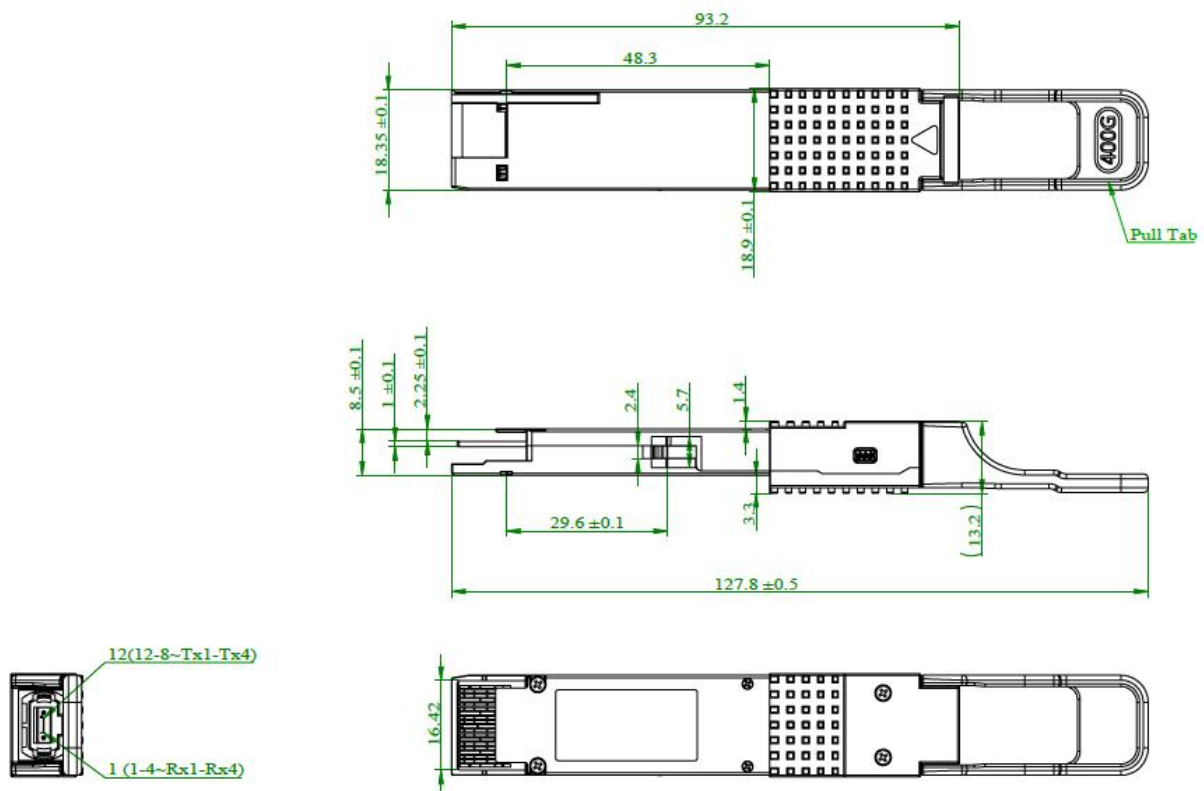

Ordering Information

Table 11 - Ordering Information

Part No.	Application	Data Rate	Laser Source	Fiber Type
EQD3140X-3MCD2	400GBASE-DR4+	400GB Ethernet	EML	Single Mode Fiber

Warnings

- Handling Precautions: This device is susceptible to damage as a result of electrostatic discharge (ESD). A static free environment is highly recommended. Follow guidelines according to proper ESD procedures.
- Laser Safety: Radiation emitted by laser devices can be dangerous to human eyes. Avoid eye exposure to direct or indirect radiation.

Compatibility Test

In order to ensure the product compatibility, our products will be tested on the switch before shipment. Our modules can be compatible with many mainstream brand switches, such as Cisco, Juniper, Extreme, Brocade, IBM, H3C, HP, Huawei, D-Link, Mikrotik, ZTE, TP-Link...

Our test equipment: VOLKTEK MEN-4110, HP 2530-8G, CRS226-24G-25+RM, Catalyst 2960G Series, Catalyst 3850 XS 10G SFP+, Catalyst 3750-E Series, HUAWEI S5700Series, H3C S3100V2 Series, Juniper-EX4200, etc.



Cisco Catalyst 3850



HUAWEI S5700



H3C S3100V2



HP J9264AR



Juniper EX 4200



Alcatel 6850E-U24X



Mikrotik CR5226-24G-25+RM



Cisco Catalyst 2960G



Volktek MEN-4110

Product Production Process

Quality Assurance

Continuous introduction of new equipment, produced by strict standards, strict quality inspection, to guarantee the high quality standard of each product.



**Standardized
Production Line**



**Professional
Welding**



Assembling

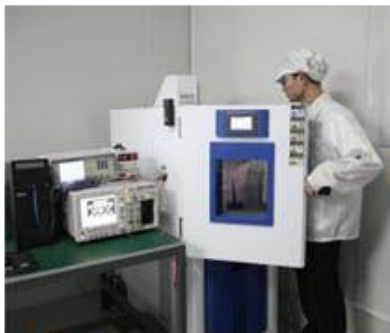

Aging Testing

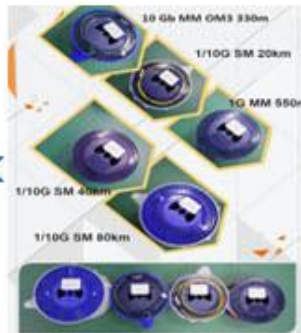

Distance Testing



Cleaning end face



Product Initial Test



Switch Testing



Product Final Test

Packaging

ETU-Link provides two kinds of packaging, 10pcs/Tray and individual package.



Company: ETU-Link Technology Co., LTD

Address: Right side of 3rd floor, No. 102 building, Longguan expressway, Dalang street, Longhua District, Shenzhen city, Guangdong Province, China 518109

Tel: +86-755 2328 4603

Address and phone number also have been listed at www.etulinktechnology.com

Please e-mail us at sales@etulinktechnology.com or call us for assistance.